



*WorldTalk Traveler
Talking Translator*

**12 Language Talking Translator
Instruction Manual**

**Translates and Talks over 720,000 Words
Translates and Talks 39,600 Travel Phrases
History and Favorite lists
8 Metric Conversions
8 Currency Conversions
International clothing and shoe converter
Sudoku Game
Time zone in 360 cities**

OPERATIONAL NOTES

Thank you for your purchase of our lingo Translator. To insure trouble-free operation of your Translator, we recommend the following:

1. The Translator should be kept in area free from extreme temperature changes, moisture and dust.
2. This equipment is precision-built. Do not subject the translator to strong shock by striking or dropping it.
3. A soft, dry cloth should be used to clean the translator. Do not use solvents or a wet cloth.
4. Never disassemble or attempt to repair the translator and its accessories. Keep this manual for further.

FEATURES

1. The TRANSLATOR translates 12 languages.
2. HUMAN VOICE inbuilt, instant speech of 12 languages and whole data.
3. Operational menu with 12 languages, you can select to use your mother language to be the operational menu.
4. 12 digits CALCULATOR can do memory and percent calculations as well as standard arithmetic operations.
5. GEO-DATA including time conversion for 360 cities.
6. CURRENCY CONVERSION functions as a currency converter for 8 denominations of your choices.

7. METRIC CONVERSION converts automatically 8 different types of measurement.
8. LIGHT/DARK DISPLAY allows you a choice of 16 levels either light display or dark display.
9. Read by 160 x 51 DOTS MATRIX DISPLAY.
10. AUTOMATIC POWER OFF conserves battery power allows you a choice by turning off the translator from 1 to 15 minutes.

BATTERY FITTING

Your translator is powered by two AAA batteries in the main power supply. When the power level of the batteries is low, the sound becomes weak and hoarse, the display is dim. If happens, replace 2xAAA alkaline battery immediately. The actual service life depends on the batteries you use, we recommend:

- Replace the 2 pcs AAA batteries supplied with the unit not longer than 3 months of purchasing.
- When inserting new batteries to be sure to insert them ensuring proper polarity (+ , -) .
- Never mix batteries of different types.
- Never mix old batteries and new ones.
- Never leave dead batteries in the battery compartment.
- If the Translator is not used for an extended period of time, please remove the batteries.

Replacing the main battery:

Before replacing the main battery.

- a) Turn off the machine.
- b) Slide off the battery door according the direction of the arrow indicated. The battery door is linkage with translator case.
- c) Remove the old batteries and replace 2 PCS AAA batteries (1.5 V, SUM-4, R3) in the correct polarity corresponding to the symbol indicated inside the battery compartment.
- d) Make sure that the batteries make a good contact with the metal plates.
- e) Cover the battery door.

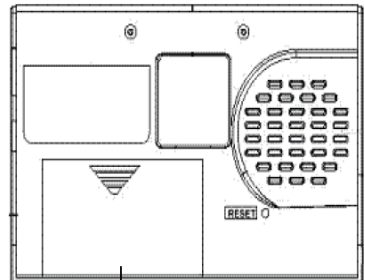





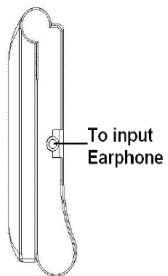
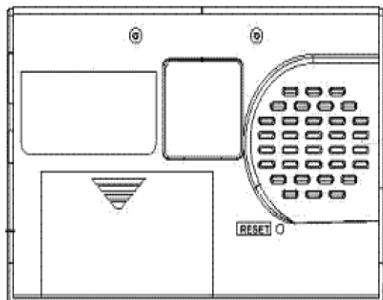



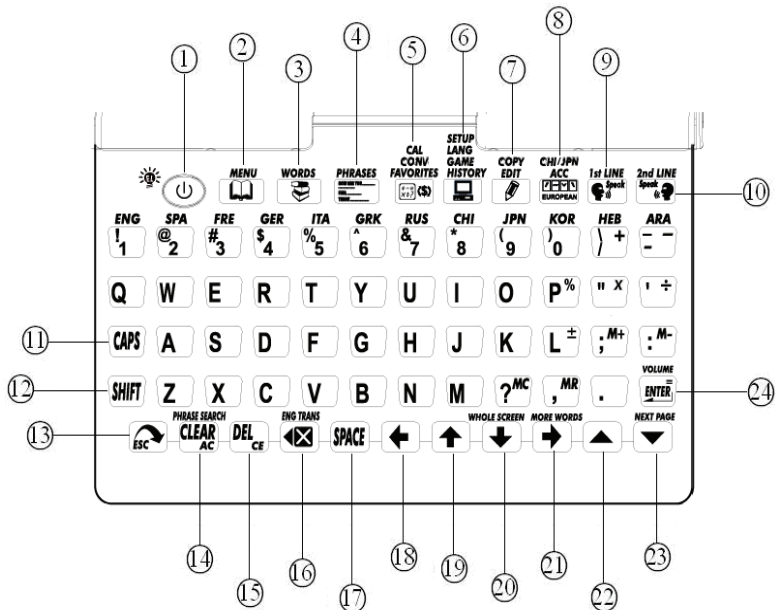

Battery door

OVERVIEW THE TRANSLATOR















NAME OF KEYS



1. ON/OFF  : a) Turn on & off. The translator will automatically switch off if you do not press any keys from 1 to 15 minutes .
(please set up the time from 1 to 15 minutes in Set Up Mode)
b) Some models have backlight which you can find  icon on the On/Off button. To get backlight, press and hold the ON/OFF button for approximately 1 to 2 seconds.
2. MENU  : Press this button to enter to menu.
3. WORDS  : Enter single word.
4. PHRASES  : Enter category to get 3300 sentences
5. CAL/ CONV. /GEOGRAPHY/FAVORITES : a) Press once to go to Calculator mode.
b) Press twice to go to Currency mode.
c) Press triply to go to GEO-DATA mode.
d) Press four times to go to Metric mode.
e) Press five times to go to FAVORITES.
- 
6. SET UP/LANG/GAME/HISTORY : a) Press once to go to Set Up Mode.
b) Press twice to go to Game mode.
c) Press triply to go to select your language message.
d) Press four times to go to HISTORY.
- 
7. EDIT  : a) Press this key to amend data.
b) In dictionary or phrases mode, press this key to copy the contents to FAVORITES mode.
8. EUROPEAN  : When you are in European input, press this key to get the European accent. When you are in Chinese input, press this key to select the Chinese input method. There are two input methods in Chinese. When you are in Japanese input, press this key to select the

Japanese Input method. There are two input methods in Japanese.

9. 1st line speak : Speak key for language on top line of display. Press this key to hear the voice for the first language which shown on the top line of display.

10. 2nd line Speak : Speak key for language on bottom line of display. Press this key to hear the voice for the second language which shown on the bottom line of display.

11. CAPS  : Press once to get Capital letter; press again to retrieve small.
12. SHIFT  : Shift to get other letter apart from main letter.
13. ESC  : Press this key to return to last screen.
14. CLEAR / AC :
 :
a) To clear the whole input in the translator mode.
b) As the 'AC' key in Calculator mode.
c) In phrases mode, press this key to clear the screen and input
15. DEL / CE  :
a) Delete, to delete the letter with cursor.
b) As the "CE' key in calculator mode.
16. Backspace  :
a) To clear the last input.
b) Press this key to get English Dictionary.
17. SPACE  : Provide an interval.
18. Left key  : To move the cursor leftward.
19. Up key  : To move the cursor upward.
20. Down key  : To move the cursor downward; or to see whole screen.
21. Right  : To move the cursor rightward; or to see more words from database.

22. Pg Up 

23. Pg Dn 

24. ENTER 

: Page UP key, to move screen to the last page.

: Page Down key, to move screen to the next page.

: a) Press this key to have translation in Translator mode.

b) Press this key to confirm the setting in set up mode.

DISPLAY SYMBOLS

display the language match with the keyboard

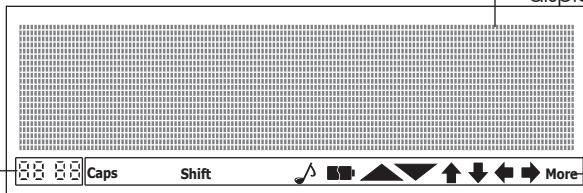

Standard display area

Status bar with symbols

 : Indicate the language which you are using. The first 2 digits is for the input language; the second 2 digits is for the translation. The language number is printed on the keyboard. E.g. 01 = English, 03 = French.

Caps : Indicate that it is in Capital Alphabet.

Shift : Indicate that it is in Shift status.

 : Indicate that keyboard is with tone .

 : Indicate that the battery power level is in low status.

 : Indicate that you can press these PAGE UP or PAGE DOWN key to scroll further.

 : Indicate that you can press Left or Right keys to see further.

 : Indicate that you can press Up or Down keys to scroll further.

BACKLIGHT DISPLAY

- The built-in backlight will enable you to read the LCD in dark.
- Your translator comes with a backlight feature. To switch on the backlighting, do the following:
- Press and hold the <ON/OFF> button for approximately 1 to 2 seconds.
- The lighting switches on and remains on for as long as keys are pressed. Otherwise, the lighting is automatically switched off after a certain period of time to save battery power.
- To switch off the background lighting manually, press <ON/OFF> again and hold it for 1 to 2 seconds.
- The backlighting consumes battery power and therefore reduces the operating life of the batteries. We recommend that you use the backlighting sparingly.

NOTE: If you find an abnormal screen which might be with interference by unexpected reasons, you can reset your machine.

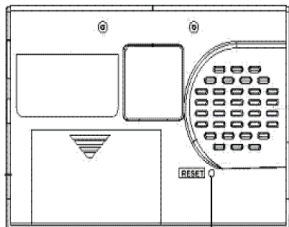

To reset the machine:
Use a thin, pointed object to
press the reset hole.

OPERATION

Before starting, please read this instruction manual carefully and be sure follow the correct operating procedures. Keep this instruction manual for future reference.

SWITCH ON YOUR TRANSLATOR - *To switch the Translator on, press <ON/OFF>. The device always starts in the mode that was active when it was last switched off. For example, if you were in calculator mode during the last use, you will be in calculator mode again when you switch the device back on.*

The translator automatically switches off if no key is pressed for a certain period. You can select this time period from 1 minute to 15 minutes. Go to <SET UP> mode, number 3 (off time), from this mode, you can select to set your machine to have automatically switch off time of 1 minute to 15 minutes.

SET UP :

Press SETUP to adjust the basic settings of the Translator. Various options are available in the setup menu. Press once of this button to have general settings. Press twice of this button to have Game mode. Press triply of this button to have language setting for interface. Press four times to History.

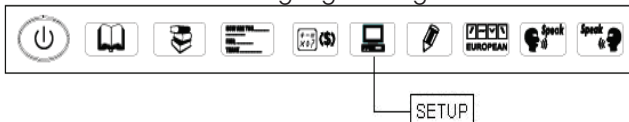

A. LANGUAGE DISPLAY

You can select any one of the 12 languages to be the interface. Use left right up down ($\uparrow \downarrow \leftarrow \rightarrow$) keys or Page UP/Down ($\blacktriangle \blacktriangledown$) key to select your language, and press ENTER to confirm.

e.g. ENG = English message, ESP = Spanish message. Highlight the ENG and press SET UP again to select other general settings.

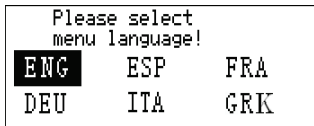

B. OTHER SETTINGS

There are also following settings:

1. KEY SOUND :

You can select to have tone or without tone when you press any keys on keyboard.

1.1 Press 1 in setup mode, display shows:

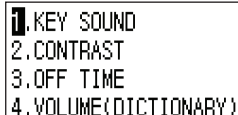

```
1. KEY SOUND
2. CONTRAST
3. OFF TIME
4. VOLUME(DICTIONARY)
```

1.2 Press 1 to have tone on, you will find an "🎵" icon of the key tone lights on meanwhile there is a tone when you press any keys.

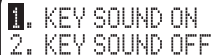

```
1. KEY SOUND ON
2. KEY SOUND OFF
```

2. LCD CONTRAST

There are 16 levels light or dark display which you can adjust with your choice.

2.1 Press 2 in setup mode, the CONTRAST, display show:

2.2 Press "LEFT" (←) key to decrease darkness, or press "RIGHT"(→) key to increase darkness.

2.3 Press ENTER until you find an optimal display contrast.



3. OFF TIME

The translator automatically switches off if no key is pressed for a certain period. You can select this time period from 1 minute to 15 minutes. In this mode, you can select to set your machine to have automatically switch off time of 1 minute to 15 minutes.

3.1 Press 3 in the setup mode, display shows:

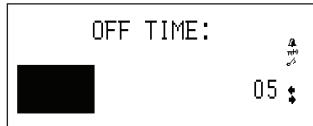

3.2 The translator is set up to have automatic off of 5 minutes.

Press "left" (←) key to decrease minutes, press right key to increase minutes. You can see the minute to be set showing on right lower corner of the LCD.

3.3 Press "Enter" to confirm the setting.

4. VOLUME (DICTIONARY)

Press Left and Right key <←→> can adjust the volume, and then press [ENTER] key to return to Set Up menu. While pronouncing again, the volume is adjusted.

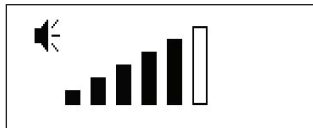

GAME - SUDOKU

The purpose of the game:

Fill in the grid so that every row, every column, and every 2 x 3 box contains digits from 1 to 6.

			1		
3		6			
	1			5	4
1	3			4	
			6		2
		1			

X Y Hint
1 1 ?
00:00:01

5	2	4	1	6	3
3	4	6	5	2	1
6	1	2	3	5	4
1	3	5	2	4	6
4	5	3	6	1	2
2	6	1	4	3	5

X Y Hint
1 1 ?
00:00:01

Game rule:

1. The number of LCD bottom denotes the place of current box, mark "?" denotes the box is empty, mark "v" denotes your input is right. Mark "x" denotes your input is error. The time is the game past time.

Press up down left right key (↑↓←→) can move box , input number "1-6" at empty box, if right, the mark "v" appear at right side, if error, the mark "x" appears. When you fulfill at the grids, press <ENTER> can see the result. If right, the display shows "You win!", if error, show "x x x".

Press ENTER to restart.

Press ESC exit SUDOKU.

USING THE TRANSLATOR

It help you to translate 12 languages instantly.

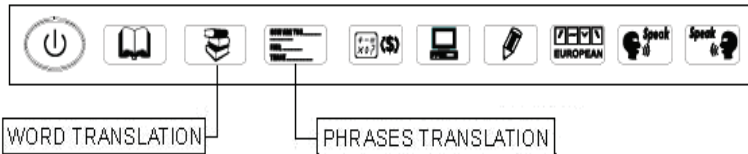

Words translation -

1. Press 'Words' key, display 'INPUT ENG:'
2. If you like to input other language, just press the number key,
e.g. press 2 to input Spanish, press 4 to input German.
3. Press 1 return to "Input ENG", type in your word e.g. car, press "ENTER" display flashes "Found: 30" and shows the translation of Spanish "coche". It tells you there are 30 words related to "car".

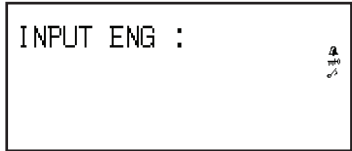

```
car
car
car coat
car park
```

```
car

FOUND: 30
```

```
■ car
■ coche
```

4. Press Right arrow key (➡) to see other 29 words related to CAR.
5. Press 8 to get Chinese translation, 9 to get Japanese translation and so on.

```
■ car
■ 汽车, 小汽车
☑ qì chē, xiǎo qì chē
```

```
■ car
■ 車
☑ kuruma
```

6. If the message is too long, press "Down" (⬇) arrow key to see the whole screen.
7. Press Page Down (▼) key to see next word.
8. To enter a new word, just type.

9. If you like to input other language, press 'Words' key and select to input other language again.
10. There is a smart system of inflective form to input the European languages.
E.g. in English, when you enter "boys", it can find the rootword "boy" and displays :

boys
bra
brace
bracelet

FOUND: 3

inflect

■ boy
■ niño

Type in "more beautiful", can display rootword "beautiful".

11. **WORD FINDING** - If the word(s) you entered is not in the database, the display will show "no record" and return to input model.

12. English to English Dictionary

There is English Dictionary to help you to catch the meaning of a headword, meanwhile its Parts of Speech.

a. Type in any word(s) you wish to translate, e.g. <shine>, press <ENTER> key, display flash "Found : 1", telling you there are 1 words relating to < shine >, and shows the <Spanish> translation.

```
■ shine
■ brillar
```

b. Press <ⓧ>, display shows :
<v. to glow or be bright with reflected light>.

```
■ shine
■ [v.]to glow or be
bright with reflected
light.
```

c. To enter a new word, just type.

d. The English Dictionary is only available to a headword, it is not available to the relating words.

13. FOR THE EUROPEAN LANGUAGES HAVE THEIR ALPHABET WITH ACCENT -

Simply press the original key and then European Accent key (), the display will show different alphabets and let you to select.

NOTE : *The Accent Alphabet can be formed just in their own language mode. If you press the “European” when it is not the one of alphabet in the entry language, the display has no response.*

E.g. in the entry language of French,

Type in A, display show:

Press “European” () once, display shows:

INPUT FRE : 

a
à
à
à ancien style

à
à
à
à ancien style
à angle droit

Press "European" () twice,
display shows:

```
à  
à  
à ancien style  
à angle droit
```

Press "European" () triply,
display shows:

```
à  
à ancien style  
à angle droit  
à bas prix
```

Press "European" () four times, display shows:

```
æ  
à ancien style  
à angle droit  
à bas prix
```

E.g. input German:

```
INPUT GER :  
↵
```

Type in S, display show:

```
S  
S.  
Saal
```

Press "European" (),
display shows:

```
ß  
T  
Tabak  
tabellarisch
```

14. Chinese Input method:

There are 2 input methods in Chinese. First is the PinYin, another is the WuBe. Press () Chinese Input key to select your input method. For example you selected PinYin “拼” input method, e.g. type ‘ai’, it will display all the characters with phonetic of ‘ai’, you select one and press the number of its position to take this character.

E.g. Press 1 to display “爱”.

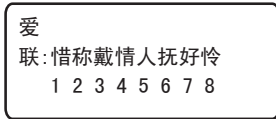
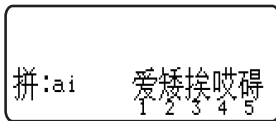

15. Japanese Input method:

There are 2 input methods in Japanese. First is the Katakana “かな”, another is the Roman “ローマ字”. Press () Japanese Input key to select your input method. For example you selected Roman input method, e.g. type ‘AKAI’, it will turn to Japanese display, press ‘ENTER’, it displays ‘Red’ in English translation.

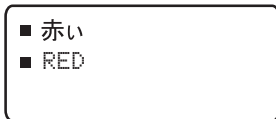

16. Korean Input method:

A Korean character is group with several parts. The translator keyboard is same as the Korean PC keyboard. E.G. in English keyboard;

1. Press R, Press K, Press Enter
2. Press W, Press K, Press D, Press Enter
3. Press ENTER
4. You can find the English translation of 'MOST' on screen.



- 가장
- MOST

Phrases translation -

There are 3300 phrases divided into 16 categories and 170 subjects.

16 Categories and the subjects:

1. **COMMUNICATION** - Phrases, Gratitude, Apology, Asking Again, Basic Question, Greetings, Saying Goodbye, Conversation, Invitation, Expressing Sympathy, Emotion, Blame, Congratulations.
2. **ACCOMMODATION** - Looking for a Hotel, Reservation, Checking in, Front Desk, Concierge, Room Service, Laundry, Operator, Problem, Business Centre, Checking Out, Barber/Beauty shop, Youth Hostel.
3. **MEALS** - Looking for a Restaurant, Reservation, Order, Waiter's Service, Payment, Fast-Food; Deli, Cafeteria; Bar, Chinese Food - Beijing Cuisine, Chinese Food - Shanghai Cuisine, Chinese Food - Szachung Cuisine, Chinese Food - Cantonese Cuisine, Japanese Food, Thai Food, Vietnamese Food, Korean Food, Indian Food, French Food, Italian Food, Mexican Food, Western Food.
4. **SIGHTSEEING** - Leaving a Country, In the plane, Entering a Country, Tourist Information, Sightseeing/Tours, Exchanging Money, Photography, Baggage Claim, Customs.
5. **TRANSPORTATION** - Asking for the way, Airplane, Ship, Train, Under-ground Railway, Taxi, Bus, Car, Map.
6. **ENTERTAINMENT** - Recreation, Bar, Night Club, Karaoke, Disco, Sauna Bath, Casino, Sports, Scuba Diving, Tennis, Golf.
7. **SHOPPING** - Looking for a Store, Purchasing, Bargaining, Paying, Clothes/Tailor, Claim.

8. **EMERGENCY** - Asking for Help, Lost/Theft, Sudden Illness/Injury, Symptoms/Diseases, Hospital, Consult a Doctor, Pharmacy, Threat, Swindle, Car Accident, Fire, Beach/Pool, Natural Disaster/Terrorism, Insurance Company.
9. **TELECOM/MAIL** - Mailing, Telephone.
10. **BUSINESS CONVERSATION** - Meeting, Payment Terms, Letter of Credit (L/C), Shipment Documents, General Term of Trade, Interview.
11. **BASIC** - Numbers, Time, Date/Week/Months, Colors, Figure, Position, Unit.
12. **GENERAL KNOWLEDGE** - Weather/Geography, Country, City, Vacation Places, Animal, plant, Insect.
13. **LIVING** - Housing, Electrical Appliances, Furniture, Sleeping Set, Clothing, Shoes/ Hosiery/ Headgears, Size/Materials, Toiletry, Cosmetic, Skin Care, Jewelry & Accessories, Souvenirs, Office Appliance, Tele-communication Products, Tools.
14. **FOOD** - Beverages, Meat, Vegetable, Sea Food, Daily Food, Bar Snack, Fruit, Meals, taste, Cooking, Condiments, Chinese Dessert, Western Dessert, Chinese Snack, Western Snack, Liquor, Dinner Set.
15. **HUMAN BEING** - Family, Education, Occupation, Marriage, Race, Religion, Society, Festival, Zodiac, Music/Musical Instruments, Chinese Year/ Birth of 12 Animals.
16. **SPORT** - Ball Games, Water Sports, General Sports, Terms of Games, Swimming, Golf.

1. Press 'Phrases' key,

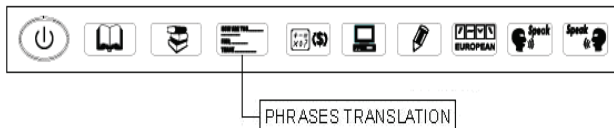

displays category :

'COMMUNICATION' 'ACCOMMODATION'.

You can change to other language by pressing the number key.

2. Press "Up/Down key" (↑↓) to search your category, or simply type in the first alphabet of the category, e.g. 'B', it goes to 'BUSINESS CONVERSATION'.
3. ENTER to 'BUSINESS CONVERSATION', you will find there are 6 subjects.
4. Use "Up/Down" key (↑↓) to go to the subject, e.g. SHIPMENT DOCUMENTS, Press ENTER.
5. You can see on display the first phrase of 'air waybill' and it's translation; press "Page Down " (▼) key to see next phrase 'bill of lading'.

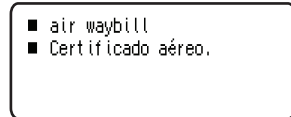
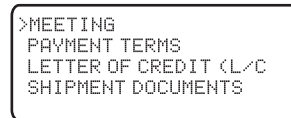
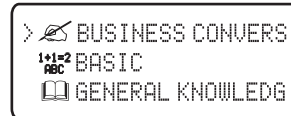

Quick search Phrases -

1. Press Phrases key, display category 'COMMUNICATION' 'ACCOMMODATION'.
2. Press PHRASE SEARCH (CLEAR) key to clear screen, type in the word, e.g. 'sympathy', press "ENTER", displays shows searching symbol, and goes to a subject 'sympathy'.
3. Press ENTER to search more phrases in this subject.

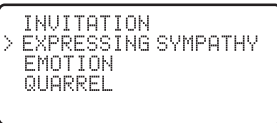
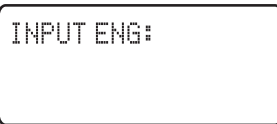

TO HEAR VOICE

The Translator speaks 12 languages, English, Spanish, French, German, Italian, Greek, Russian, Chinese, Japanese, Korean, Hebrew and Arabic.

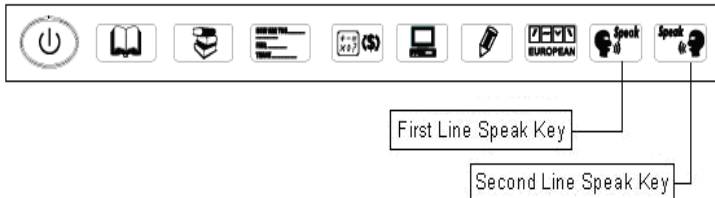

1. Press the "1st LINE" speak key to hear the voice for the language on the top line of display and the "2nd LINE" speak key for the language on the bottom line.
E.g. Input ENG 'bookshop', press ENTER to get Spanish translation, display shows:

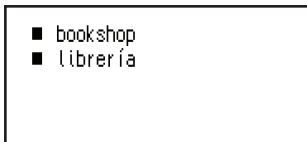

Press the "1st LINE" speak key, you can hear the English voice "bookshop".
Press the " 2nd LINE" speak key, you can hear the Spanish voice "librería".

2. It is with the same procedure to hear the phrases. Press the "1 st LINE" speak key to hear the ENTRY LANGUAGE, the "2nd LINE" speak key to hear the LANGUAGE OF TRANSLATION.
3. The voice volume can be adjusted to a high level that is clear enough in outdoor environment. However, a medium voice lever is recommended for general learners to use the translator in indoor environment while the best effect can obtained by using an earphone (optional accessory).
4. Press "SHIFT" key, and then press "Speak1" or "Speak2" can continue to pronounce.

Using the FAVORITES function

1. Under the paraphrase interface, press [ EDIT] key to copy the word you like, display shows:
2. Press "Y" for Yes to Save or press "N" for No, display returns to the last mode.
3. Choose the "3" on the menu to have favorites contents display:
4. To choose a word "good" and ENTER to see the content. Display shows:
5. To delete a data, go back to the list and choose the required word, press [DEL] key, display shows:
6. Press "Y" for Yes to Save or press "N" for No, display returns to the last mode.

```
PASTE TO FAVORITES
(Y/N) ?
```

```
good
dab
shine
baby
```

```
■ good
■ bueno
```

```
DELETE
(Y/N) ?
```

Using the HISTORY function

1. Choose the "4" on the menu to have history of dictionary display.
2. To choose a word "shine" and ENTER to see the content, display shows:

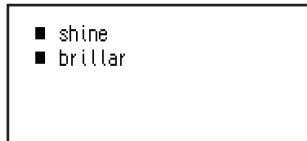
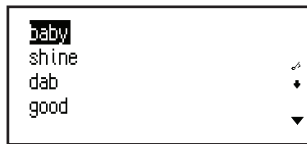

USING THE CALCULATOR

You can use the Translator to do standard arithmetic calculations, memory calculations and percent calculations. It calculates up to 12 digits.

1. Press "CAL" (calculator) to go into the calculator mode, display shows:
2. Standard calculation, +, -, x, ÷.
3. Memory calculation:
(M+) to total a calculation and add the total a memory.
(M-) to total a calculation and subtract the total from the value in memory.
(MR) to recall or display the value in memory.
(MC) to clear the memory.
4. Press "CE" or "AC" to clear display and calculation.

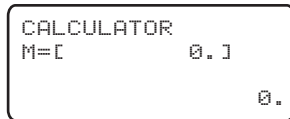

USING THE CURRENCY CONVERSION

The Translator can convert between 8 user-programmed currencies and your own denomination.

1. SETTING THE CURRENCY AND EXCHANGE RATES

1.1 Enter to "CURRENCY", display shows:

1 = CURRENCY ONE	RATE = EXCHANGE RATE
USD = US Dollars	EUR = EURO Dollars

```
1 2345678
RATE=[      1.]
>USD      0
EUR      0.
```

1.2 Press "EDIT" (), the exchange is flashing:

```
1 234567 8
RATE=[      1.1
>USD      0.
EUR      0.
```

1.3 Change the exchange rate by type in a new rate, e.g. US Dollar one approximately equals to 0.992 EUR.

```
1 234567 8
RATE=[      0.9921
>USD      0.
EUR      0.
```

1.4 Press "Enter" to confirm the rate.

1.5 To change a currency name, e.g. change USD to CHF. Press EDIT to make the exchange rate flashing, and then press DOWN key (↓) to move the flashing to the currency USD, press DOWN key (↓) once more to move to EUR.

```
1 234567 8
RATE=[      0.9921
>USD      0.
EUR      0.
```

1.6 Type in a new currency CHF to instead of EUR.

- 1.7 Press "ENTER" to confirm the currency name.
- 1.8 The Translator programs the following 8 currencies, you can make your own denomination according to above procedure. Use Left & Right (←→) key to move to view other currencies.
 - 1 = USD > EUR (Euro)
 - 2 = USD > GBP (Great British Pound)
 - 3 = USD > RMB (Chinese Ren Min Bi)
 - 4 = USD > JPY (Japanese Yen)
 - 5 = USD > KRW (Korean Won)
 - 6 = USD > TAB (Thai Baht)
 - 7 = USD > CAD (Canadian Dollar)
 - 8 = USD > AUD (Australian Dollar)

2. CONVERTING CURRENCY

- 2.1 Enter to "CURRENCY", display shows the first currency US Dollar to EURO.
- 2.2 Type in the amount, e.g. USD 1,000 display shows:
- 2.3 To make 2 currencies inverse, press Up or Down (↑↓) key.
E.g. To find EUR to what amount of US Dollars.
Press Down (↓) key, the arrow will go down to EUR.

```

1 2 3 4 5 6 7 8
RATE=[ 0.992]
>USD      0 .
EUR       0 .
  
```

```

1 2 3 4 5 6 7 8
RATE=[ 0.992]
>USD     1000.
EUR      992.
  
```

```

1 2 3 4 5 6 7 8
RATE=[ 0.992]
USD      0 .
>EUR     0 .
  
```

2.4 Type in 1000, display shows:
(i.e. EUR1000=USD 1008.06451613)

```
12345678
RATE=[      0.992]
USD 1008.06451613
>EUR      1000.
```

2.5 To clear display for next calculation, press CE or AC.

USING THE GEO-DATA

GEO-DATA shows the data of 360 major cities in the world, includes: Country name, Zone, Dial Code and Volt.

Enter to "GEO-DATA", display shows:

```
1. VIEW
2. SEARCH
```

Use **↑↓** key to choose the ways to view the data.



1. Enter "1. VIEW", the display shows:

```
City: Kabul
Zone: +4.5
Dial Code: +93
Volt: 220V
```

Press **▲▼** key to see the previous or the next Country's data.

2. Enter "2. SEARCH", display shows:

```
1.Abidjan  
2.Abu Dhabi  
3.Acapulco  
4.Addis Ababa
```

You can type in the first letter of the Country name and then use  or  key to search for the Country you like and press Enter to see the detailed contents, display shows:

Press  key to return.

```
City: New York  
Zone: -5  
Dial Code: +1  
Volt: 120V
```

USING THE METRIC CONVERSION

The Translator can convert one type of measurement to another. The following 8 related pairs are built-in the unit and they can be inverse : °C(Celsius) to °F (Fahrenheit) ,M (Metre) to F (Feet), CM (Centimetre) to IN (Inch), L(Litre) to GL(US Gallon), L(Litre) to BG (British Gallon), KB (Kilogram) to LB (Pound),G (Gram) to OZ (Ounce) and A (Are) to AC (Acre).

1. Enter to "METRIC", display shows °C- and the formula for Celsius to Fahrenheit.

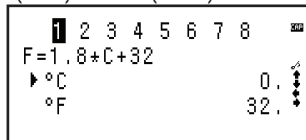

Calculator display showing the formula $F=1.8 \times C + 32$ and unit conversion options. The display shows a cursor at the beginning of the line, followed by the formula, and then the unit options: °C and °F. The value 0. is shown next to °C and 32. is shown next to °F.

2. Enter the amount, e.g. 25 °C, press 25, display shows, from Celsius to Fahrenheit, i.e. 25 °C = 77 °F.

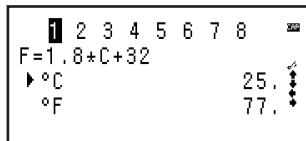

Calculator display showing the conversion of 25 °C to 77 °F. The display shows the formula $F=1.8 \times C + 32$ and the unit options: °C and °F. The value 25. is shown next to °C and 77. is shown next to °F.

3. To convert from Fahrenheit to Celsius, press "Down" (↓) key to move to display shows:

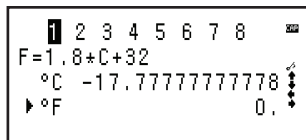

Calculator display showing the conversion of 0 °F to -17.77777777777778 °C. The display shows the formula $F=1.8 \times C + 32$ and the unit options: °C and °F. The value -17.77777777777778 is shown next to °C and 0. is shown next to °F.

4. Enter the amount, e.g. 100°F, type 100, display shows:
5. Press "Right" key (➡) to see other conversions, and "Left" key (⬅) to return.
6. The other types of measurement conversion are with same format as above.
7. Press ESC (⏏) to return to select conversion screen.

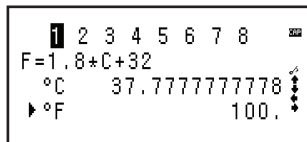

3. USING THE SIZE CONVERSION

You can use the Translator to convert the garment size.

1. Enter to "SIZES", the following 4 subjects are built-in the unit, display shows:
2. Use Up or Down (⬆⬇) keys to select the desired subcategory.
e.g. <Woman shoes>.
Press <ENTER>, display shows:
3. Use Left & Right (⬅➡) key to move to see other sizes conversion.



America	5 ^{1/2}	6	6 ^{1/2}	7
Britain	4 ^{1/2}	5	5 ^{1/2}	6
Italy	37	37 ^{1/2}	38	38 ^{1/2}
Japan	23	23 ^{1/2}	24	24 ^{1/2}
Spain	36	37	38	39

America	6	6 ^{1/2}	7	7 ^{1/2}
Britain	5	5 ^{1/2}	6	6 ^{1/2}
Italy	37 ^{1/2}	38	38 ^{1/2}	39
Japan	23 ^{1/2}	24	24 ^{1/2}	25
Spain	37	38	39	40

FOLLOW THE CORRECT OPERATING PROCEDURES, WE SINCERELY HOPE THAT YOU WOULD ENJOY THE INTEREST OF THE TRANSLATOR.